

ABN 27 117 521 598

The Direct Connection →

Mark Heffernan Qld Pty Ltd

The Australian distributor of
Reusable



Catalogue

2014



**INDICE
INDEX**

Pag. 7.1 - 7.2

**ISTRUZIONI DI MONTAGGIO
ASSEMBLY INSTRUCTIONS**

Pag. 7.3



**FEMMINA GIREVOLE GAS
CONO 60° RECUPERABILE
REUSABLE BSP SWIVEL
FEMALE 60° CONE**

Cod. RECBSPSF..

Pag. 7.4



**FEMMINA GIREVOLE 90° GAS
CONO 60° RECUPERABILE
90° REUSABLE BSP SWIVEL
FEMALE 60° CONE**

Cod. REC90BSPSF..

Pag. 7.5



**FEMMINA METRICA CONO 24°
RECUPERABILE - SERIE L
REUSABLE O'R METRIC
FEMALE 24° CONE - L SERIE**

Cod. RECORMSFL..

Pag. 7.6



**FEMMINA METRICA 90° CONO 24°
RECUPERABILE - SERIE L
REUSABLE 90° O'R METRIC
FEMALE 24° CONE - L SERIE**

Cod. REC90ORMSFL..

Pag. 7.7



**FEMMINA METRICA CON 24°
RECUPERABILE - SERIE S
REUSABLE O'R METRIC
FEMALE 24° CONE - S SERIE**

Cod. RECORMSFH..

Pag. 7.8



**FEMMINA METRICA 90° CONO 24°
RECUPERABILE - SERIE S
REUSABLE 90° O'R METRIC
FEMALE 24° CONE - S SERIE**

Cod. REC90ORMSFH..

Pag. 7.9



**FEMMINA GIREVOLE JIC
SV.74° RECUPERABILE
REUSABLE JIC SWIVEL
FEMALE 74° CONE**

Cod. RECJSF..

Pag. 7.10



**ERMETO RECUPERABILE
REUSABLE STANDPIPE**

Cod. RECSLH..

Pag. 7.11



**ERMETO 90° RECUPERABILE
REUSABLE 90° STANDPIPE**

Cod. REC90SLH..

Pag. 7.12



**MASCHIO GAS CILINDRICO
SV. 60° RECUPERABILE
REUSABLE BSP MALE
PARALLEL 60° CONE**

Cod. RECBSPM..

Pag. 7.13



**MASCHIO GAS CONICO
SV. 60° RECUPERABILE
REUSABLE BSP TAPER
MALE 60° CONE**

Cod. RECBSPTM..

Pag. 7.14



**MASCHIO NPT SV. 60° RECUPERABILE
REUSABLE NPT MALE 60° CONE**

Cod. RECNPMT..

Pag. 7.15



**MASCHIO METRICO SV. 24°
RECUPERABILE - SERIE L
REUSABLE METRIC MALE
24° CONE - L SERIE**

Cod. RECMLL..

Pag. 7.16



**MASCHIO METRICO SV. 24°
RECUPERABILE - SERIE S
REUSABLE METRIC MALE
24° CONE - S SERIE**

Cod. RECMMH..

Pag. 7.17



**GHIERA R1 RECUPERABILE PER TUBO:
SAE 100 R1AT (EN 853 1SN) -
EN 857 2SC - EN 854 2TE
REUSABLE R1 FERRULE FOR:
SAE 100 R1AT (EN 853 1SN) -
EN 857 2SC - EN 854 2TE HOSE TYPE**

Cod. RECFR1..

Pag. 7.18



**GHIERA R2 RECUPERABILE PER TUBO:
SAE 100 R2AT (EN 853 2SN) -
EN 854 3TE
REUSABLE R2 FERRULE FOR:
SAE 100 R2AT (EN 853 2SN) -
EN 854 3TE HOSE TYPE**

Cod. RECFR2..

Pag. 7.19



**GHIERA R7 RECUPERABILE PER TUBO:
SAE 100 R7 (EN 855 R7)
REUSABLE R7 FERRULE FOR:
SAE 100 R7 (EN 855 R7) HOSE TYPE**

Cod. RECFR7..

Pag. 7.20

- ISTRUZIONI DI MONTAGGIO - - ASSEMBLY INSTRUCTIONS -

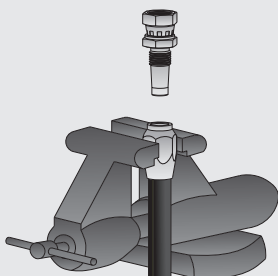
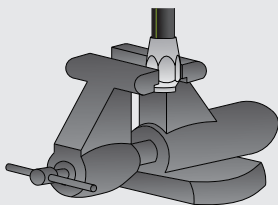
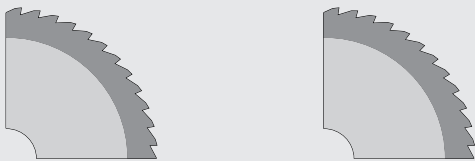
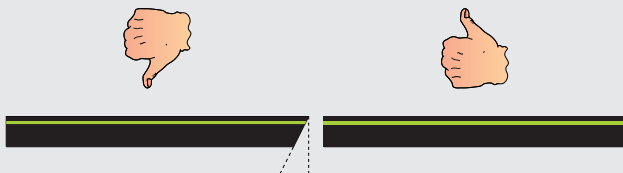

1. Tagliare il tubo a 90° alla lunghezza desiderata usando una lama affilata. Pulire il tubo accuratamente

1. Cut the hose squarely to desired length, using a sharpened blade then clean the hose.

2. Posizionare la boccola in una morsa ed avvitare il tubo in senso antiorario fino al fondo della boccola, quindi svitare di ¼ di giro.

2. Place the ferrule into a vice, screw in the hose counterclockwise until it reaches the bottom of the ferrule, then back hose out by ¼ turn.

3. Marcare sia la boccola che il tubo per poter verificare possibili torsioni del tubo quando si inserisce l'inserto

3. Mark both hose and ferrule in order to be able to check possible hose rotation while placing the insert.

4. Ingrassare le filettature dell'inserto e della boccola ed oliare l'interno del tubo abbondantemente.

4. Lubricate the threads of both the insert and the ferrule and oil the hose (on the inside) liberally.

5. Inserire l'inserto nella boccola e stringere usando una chiave, è ammessa una distanza tra esagono del raccordo e boccola pari al massimo a 3 mm. Controllare l'allineamento della boccola e del tubo per assicurarsi che non ci siano state torsioni.

5. Press the fitting into the ferrule and tighten using a wrench. A gap of 3 mm between the hexagon of the fitting and the ferrule is acceptable. Check that markings made on fitting and ferrule are lined up.

**FEMMINA GIREVOLE GAS CONO 60° RECUPERABILE
REUSABLE BSP SWIVEL FEMALE 60° CONE**

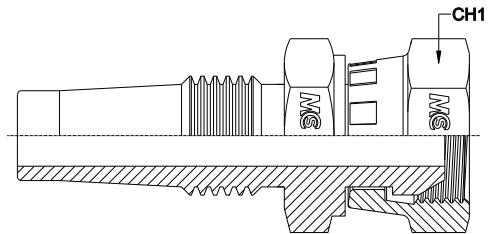

Codice Part Number	Ø Int. Tubo Tube I.D.	Filetto Thread	CH1
RECBSPSF0203	1/8"	3/16"	17
RECBSPSF0403	1/4"	3/16"	19
RECBSPSF0404	1/4"	1/4"	19
RECBSPSF0604	3/8"	1/4"	22
RECBSPSF0605	3/8"	5/16"	22
RECBSPSF0606	3/8"	3/8"	22
RECBSPSF0806	1/2"	3/8"	27
RECBSPSF0808	1/2"	1/2"	27
RECBSPSF1210	3/4"	5/8"	32
RECBSPSF1212	3/4"	3/4"	32
RECBSPSF1616	1"	1"	38

**FEMMINA GIREVOLE 90° GAS CONO 60° RECUPERABILE
90° REUSABLE BSP SWIVEL FEMALE 60° CONE**

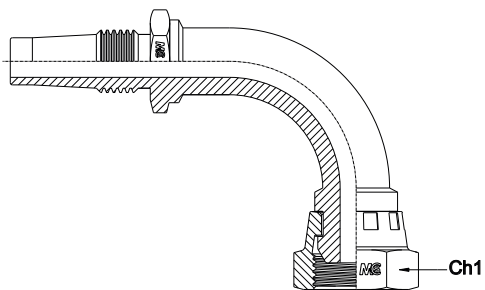

Codice Part Number	Ø Int. Tubo Tube I.D.	Filetto Thread	CH1
REC90BSPSF0203	1/8"	3/16"	17
REC90BSPSF0403	1/4"	3/16"	19
REC90BSPSF0404	1/4"	1/4"	19
REC90BSPSF0604	3/8"	1/4"	22
REC90BSPSF0605	3/8"	5/16"	22
REC90BSPSF0606	3/8"	3/8"	22
REC90BSPSF0806	1/2"	3/8"	27
REC90BSPSF0808	1/2"	1/2"	27
REC90BSPSF1210	3/4"	5/8"	32
REC90BSPSF1212	3/4"	3/4"	32
REC90BSPSF1616	1"	1"	38

FEMMINA METRICA CONO 24° RECUPERABILE - SERIE L
REUSABLE O'R METRIC FEMALE 24° CONE - L SERIE

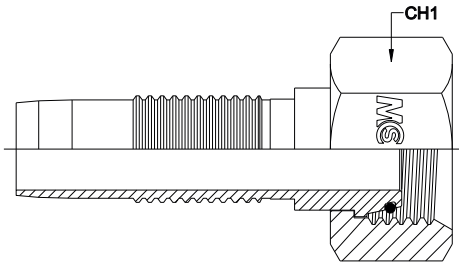

Codice Part Number	Ø Int. Tubo Tube I.D.	Filetto Thread	DIN 24°	CH1
RECORMSFL0603	3/16"	12x1,5	06L	14
RECORMSFL0604	1/4"	12x1,5	06L	14
RECORMSFL0803	3/16"	14x1,5	08L	17
RECORMSFL0804	1/4"	14x1,5	08L	17
RECORMSFL1004	1/4"	16x1,5	10L	19
RECORMSFL1005	5/16"	16x1,5	10L	19
RECORMSFL1205	5/16"	18x1,5	12L	22
RECORMSFL1206	3/8"	18x1,5	12L	22
RECORMSFL1508	1/2"	22x1,5	15L	27
RECORMSFL1810	5/8"	26x1,5	18L	32
RECORMSFL2212	3/4"	30x2	22L	36
RECORMSFL2816	1"	36x2	28L	41

FEMMINA METRICA 90° CONO 24° RECUPERABILE - SERIE L
REUSABLE 90° O'R METRIC FEMALE 24° CONE - L SERIE

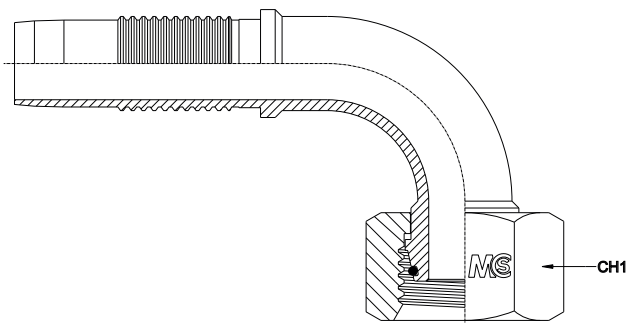

Codice Part Number	Ø Int. Tubo Tube I.D.	Filetto Thread	DIN 24°	CH1
REC900RMSFL0603	3/16"	12x1,5	06L	14
REC900RMSFL0604	1/4"	12x1,5	06L	14
REC900RMSFL0803	3/16"	14x1,5	08L	17
REC900RMSFL0804	1/4"	14x1,5	08L	17
REC900RMSFL1004	1/4"	16x1,5	10L	19
REC900RMSFL1005	5/16"	16x1,5	10L	19
REC900RMSFL1205	5/16"	18x1,5	12L	22
REC900RMSFL1206	3/8"	18x1,5	12L	22
REC900RMSFL1508	1/2"	22x1,5	15L	27
REC900RMSFL1810	5/8"	26x1,5	18L	32
REC900RMSFL2212	3/4"	30x2	22L	36
REC900RMSFL2816	1"	36x2	28L	41

FEMMINA METRICA CONO 24° RECUPERABILE - SERIE S
REUSABLE O'R MERIC FEMALE 24° CONE - S SERIE

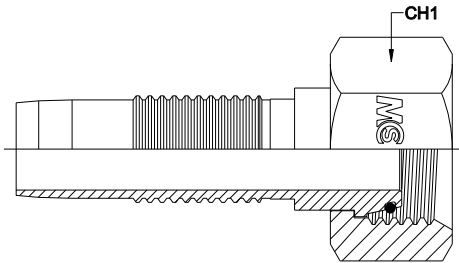

Codice Part Number	Ø Int. Tubo Tube I.D.	Filetto Thread	DIN 24°	CH1
RECORMSFH0603	3/16"	14x1,5	06S	17
RECORMSFH0604	1/4"	14x1,5	06S	17
RECORMSFH0804	1/4"	16x1,5	08S	19
RECORMSFH1004	1/4"	18x1,5	10S	22
RECORMSFH1006	3/8"	18x1,5	10S	22
RECORMSFH1205	5/16"	20x1,5	12S	24
RECORMSFH1406	3/8"	22x1,5	14S	27
RECORMSFH1608	1/2"	24x1,5	16S	30
RECORMSFH2010	5/8"	30x2	20S	36
RECORMSFH2512	3/4"	36x2	25S	46
RECORMSFH3016	1"	42x2	30S	50

FEMMINA METRICA 90° CONO 24° RECUPERABILE - SERIE S
REUSABLE 90° O'R METRIC FEMALE 24° CONE - S SERIE

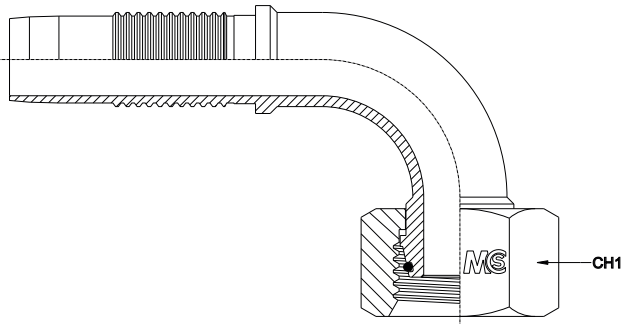

Codice Part Number	Ø Int. Tubo Tube I.D.	Filetto Thread	DIN 24°	CH1
REC900RMSFH0603	3/16"	14x1,5	06S	17
REC900RMSFH0604	1/4"	14x1,5	06S	17
REC900RMSFH0804	1/4"	16x1,5	08S	19
REC900RMSFH1004	1/4"	18x1,5	10S	22
REC900RMSFH1205	5/16"	20x1,5	12S	24
REC900RMSFH1406	3/8"	22x1,5	14S	27
REC900RMSFH1608	1/2"	24x1,5	16S	30
REC900RMSFH2010	5/8"	30x2	20S	36
REC900RMSFH2512	3/4"	36x2	25S	46
REC900RMSFH3016	1"	42x2	30S	50

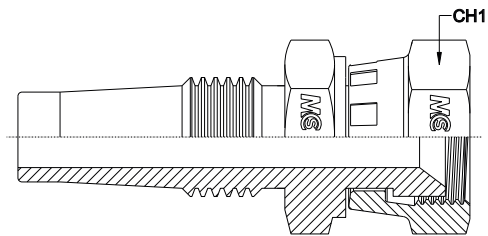
**FEMMINA GIREVOLE JIC SV. 74° RECUPERABILE
REUSABLE JIC SWIVEL FEMALE 74° CONE**

Codice Part Number	Ø Int. Tubo Tube I.D.	Filetto Thread	CH1
RECJSF0703	3/16"	7/16"	17
RECJSF0704	1/4"	7/16"	17
RECJSF0804	1/4"	1/2"	17
RECJSF0904	1/4"	9/16"	19
RECJSF0905	5/16"	9/16"	19
RECJSF0906	3/8"	9/16"	19
RECJSF1206	3/8"	3/4"	24
RECJSF1208	1/2"	3/4"	24
RECJSF1406	3/8"	7/8"	27
RECJSF1408	1/2"	7/8"	27
RECJSF1410	5/8"	7/8"	27
RECJSF1708	1/2"	1" 1/16"	32
RECJSF1710	5/8"	1" 1/16"	32
RECJSF1712	3/4"	1" 1/16"	32
RECJSF2112	3/4"	1" 5/16"	38
RECJSF2116	1"	1" 5/16"	38

Disponibili anche a 45° e 90°
Also Available 45° and 90°

**ERMETO RECUPERABILE
REUSABLE STANDPIPE**

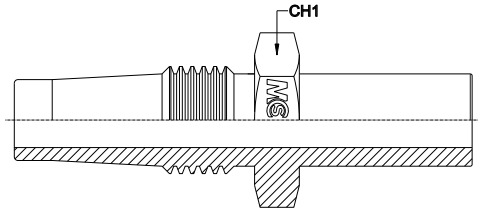

Codice Part Number	Ø Int. Tubo Tube I.D.	Filetto Thread	CH1
RECSLH0603	3/16"	06(L/S)	14
RECSLH0604	1/4"	06(L/S)	14
RECSLH0803	3/16"	08(L/S)	14
RECSLH0804	1/4"	08(L/S)	14
RECSLH1004	1/4"	10(L/S)	14
RECSLH1005	5/16"	10(L/S)	14
RECSLH1006	3/8"	10(L/S)	14
RECSLH1204	1/4"	12(L/S)	17
RECSLH1205	5/16"	12(L/S)	17
RECSLH1206	3/8"	12(L/S)	17
RECSL1508	1/2"	15(L)	19
RECSL1810	5/8"	18(L)	22
RECSL2212	3/4"	22(L)	24
RECSL2816	1"	28(L)	36
RECSH1406	3/8"	14(S)	19
RECSH1608	1/2"	16(S)	22
RECSH2010	5/8"	20(S)	24
RECSH2512	3/4"	25(S)	30
RECSH3016	1"	30(S)	*

ERMETO 90° RECUPERABILE
REUSABLE 90° STANDPIPE

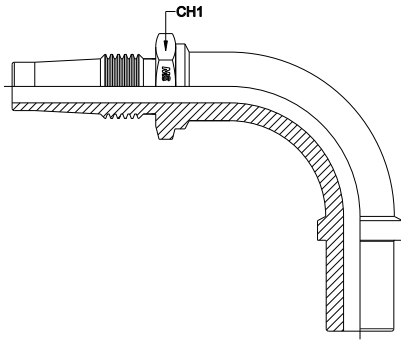

Codice Part Number	Ø Est. Tubo Tube O.D.	Ø Int. Tubo Tube I.D.	CH1
REC90SLH0603	06(L/S)	3/16"	14
REC90SLH0604	06(L/S)	1/4"	14
REC90SLH0803	08(L/S)	3/16"	14
REC90SLH0804	08(L/S)	1/4"	14
REC90SLH1004	10(L/S)	1/4"	14
REC90SLH1005	10(L/S)	5/16"	14
REC90SLH1006	10(L/S)	3/8"	14
REC90SLH1204	12(L/S)	1/4"	17
REC90SLH1205	12(L/S)	5/16"	17
REC90SLH1206	12(L/S)	3/8"	17
REC90SL1508	15(L)	1/2"	19
REC90SL1810	18(L)	5/8"	22
REC90SL2212	22(L)	3/4"	24
REC90SL2816	28(L)	1"	36
REC90SH1406	14(S)	3/8"	19
REC90SH1608	16(S)	1/2"	22
REC90SH2010	20(S)	5/8"	24
REC90SH2512	25(S)	3/4"	30

MASCHIO GAS CILINDRICO SV. 60° RECUPERABILE
REUSABLE BSP MALE PARALLEL 60° CONE

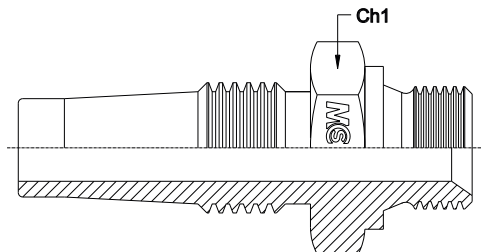

Codice Part Number	Ø Int. Tubo Tube I.D.	Filetto Thread	CH1
RECBSPM0403	3/16"	1/4"	19
RECBSPM0404	1/4"	1/4"	19
RECBSPM0604	1/4"	3/8"	22
RECBSPM0605	5/16"	3/8"	22
RECBSPM0606	3/8"	3/8"	22
RECBSPM0806	3/8"	1/2"	27
RECBSPM0808	1/2"	1/2"	27
RECBSPM1210	5/8"	3/4"	32
RECBSPM1212	3/4"	3/4"	32
RECBSPM1612	3/4"	1"	38
RECBSPM1616	1"	1"	38

MASCHIO GAS CONICO SV. 60° RECUPERABILE
REUSABLE BSP TAPER MALE 60° CONE

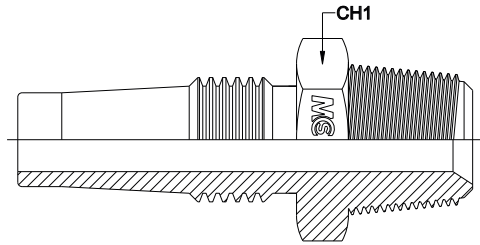

Codice Part Number	Ø Int. Tubo Tube I.D.	Filetto Thread	CH1
RECBSPTM0403	3/16"	1/4"	14
RECBSPTM0404	1/4"	1/4"	14
RECBSPTM0604	1/4"	3/8"	19
RECBSPTM0605	5/16"	3/8"	19
RECBSPTM0606	3/8"	3/8"	19
RECBSPTM0806	3/8"	1/2"	22
RECBSPTM0808	1/2"	1/2"	22
RECBSPTM1210	5/8"	3/4"	27
RECBSPTM1212	3/4"	3/4"	27
RECBSPTM1616	1"	1"	36

**MASCHIO NPT SV. 60° RECUPERABILE
REUSABLE NPT MALE 60° CONE**

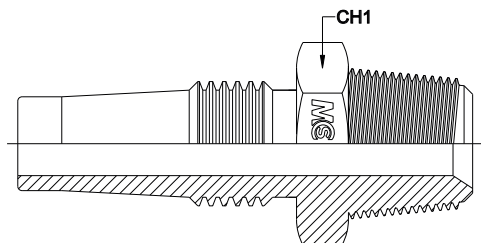

Codice Part Number	Ø Int. Tubo Tube I.D.	Filetto Thread	CH1
RECNPMT0403	3/16"	1/4"	14
RECNPMT0404	1/4"	1/4"	14
RECNPMT0604	1/4"	3/8"	19
RECNPMT0605	5/16"	3/8"	19
RECNPMT0606	3/8"	3/8"	19
RECNPMT0806	3/8"	1/2"	22
RECNPMT0808	1/2"	1/2"	22
RECNPMT1210	5/8"	3/4"	27
RECNPMT1212	3/4"	3/4"	27
RECNPMT1616	1"	1"	36

MASCHIO METRICO SV. 24° RECUPERABILE - SERIE L
REUSABLE METRIC MALE 24° CONE - L SERIE

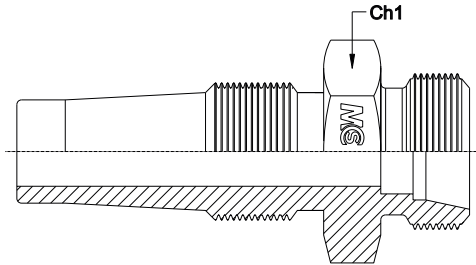

Codice Part Number	Ø Int. Tubo Tube I.D.	Filetto Thread	CH1
RECMML0803	3/16"	14x1,5	14
RECMML0804	1/4"	14x1,5	14
RECMML1004	1/4"	16x1,5	17
RECMML1005	5/16"	16x1,5	17
RECMML1206	3/8"	18x1,5	19
RECMML1508	1/2"	22x1,5	22
RECMML1810	5/8"	26x1,5	27
RECMML2212	3/4"	30x2	30
RECMML2816	1"	36x2	36

MASCHIO METRICO SV. 24° RECUPERABILE - SERIE S
REUSABLE METRIC MALE 24° CONE - S SERIE

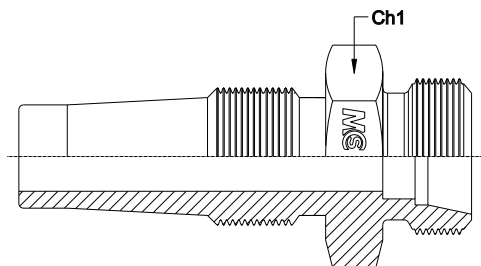

Codice Part Number	Ø Int. Tubo Tube I.D.	Filetto Thread	DIN 24°	CH1
RECMMH0803	3/16"	16x1,5	08S	17
RECMMH0804	1/4"	16x1,5	08S	17
RECMMH1004	1/4"	18x1,5	10S	19
RECMMH1205	5/16"	20x1,5	12S	22
RECMMH1406	3/8"	22x1,5	14S	22
RECMMH1608	1/2"	24x1,5	16S	24
RECMMH2010	5/8"	30x2	20S	30
RECMMH2512	3/4"	36x2	25S	36
RECMMH3016	1"	42x2	30S	46

GHIERA R1 RECUPERABILE PER TUBO:

SAE 100 R1AT (EN 853 1SN) - EN 857 2SC - EN 854 2TE

REUSABLE R1 FERRULE FOR :

SAE 100 R1AT (EN 853 1SN) - EN 857 2SC - EN 854 2TE HOSE TYPE

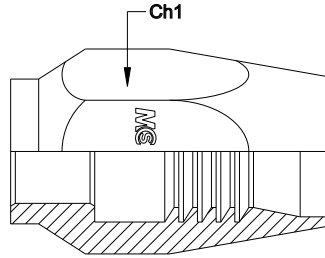

Codice Part Number	Ø Int. Tubo Tube I.D.	Filetto Thread
RECFR104	1/4"	7/16"-20
RECFR105	5/16"	1/2"-20
RECFR106	3/8"	9/16"-18
RECFR108	1/2"	5/8"-18
RECFR110	5/8"	3/4"-18
RECFR112	3/4"	7/8"-18
RECFR116	1"	1 3/16"-16

GHIERA R2 RECUPERABILE PER TUBO:

SAE 100 R2AT (EN 853 2SN) - EN 854 3TE

REUSABLE R2 FERRULE FOR :

SAE 100 R2AT (EN 853 2SN) - EN 854 3TE HOSE TYPE

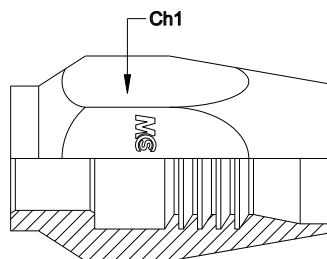

Codice Part Number	Ø Int. Tubo Tube I.D.	Filetto Thread
RECFR204	1/4"	7/16"-20
RECFR205	5/16"	1/2"-20
RECFR206	3/8"	9/16"-18
RECFR208	1/2"	5/8"-18
RECFR210	5/8"	3/4"-18
RECFR212	3/4"	7/8"-18
RECFR216	1"	1 3/16-16

GHIERA R7 RECUPERABILE PER TUBO:

SAE 100 R7 (EN 855 R7)

REUSABLE R7 FERRULE FOR :

SAE 100 R7 (EN 855 R7) HOSE TYPE

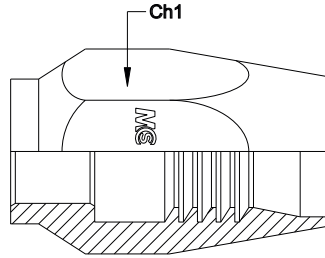

Codice Part Number	Ø Int. Tubo Tube I.D.	Filetto Thread
RECFR703	3/16"	M. 7x0,75
RECFR704	1/4"	7/16"-20
RECFR705	5/16"	1/2"-20
RECFR706	3/8"	9/16"-18
RECFR708	1/2"	5/8"-18
RECFR710	5/8"	3/4"-18
RECFR712	3/4"	7/8"-18
RECFR716	1"	1"3/16-16