



ABN 27 117 521 598

The Direct Connection →

Mark Heffernan

The Australian distributor of
Interlock fittings series





**GHIERA PER TUBO EN 856 4SH
4 SH FERRULE FOR EN 856 4SH
HOSE TYPE**

Cod. FR4SH..

Pag. 2.3



**GHIERA PER TUBO SAE 100 R13
(EN 856 R13) -
R13 FERRULE FOR SAE 100 R13
(EN 856 R13) -**

Cod. FR13..

Pag. 2.4



**MASCHIO SVASATO 60° INTERLOCK
Filetto Gas Cilindrico
INTERLOCK 60° CONE
Thread BSP Parallel**

Cod. INTBSPM..

Pag. 2.5



**FEMMINA GIREVOLE GAS
CONO 60° INTERLOCK
INTERLOCK BSP SWIVEL
FEMALE 60° CONE**

Cod. INTBSPSF..

Pag. 2.6



**FEMMINA GIREVOLE 45° GAS
CONO 60° INTERLOCK
INTERLOCK 45° BSP SWIVEL
FEMALE 60° CONE**

Cod. 45INTBSPSF..

Pag. 2.7



**FEMMINA GIREVOLE 90° GAS
CONO 60° INTERLOCK
INTERLOCK 90° BSP SWIVEL
FEMALE 60° CONE**

Cod. 90INTBSPSF..

Pag. 2.8



**FEMMINA GIREVOLE JIC SVASATA
74° INTERLOCK
INTERLOCK JIC SWIVEL
FEMALE 74° CONE**

Cod. INTJSF..

Pag. 2.9



**FEMMINA GIREVOLE 45° JIC
SVASATA 74° INTERLOCK
INTERLOCK 45° JIC SWIVEL
FEMALE 74° CONE**

Cod. 45INTJSF..

Pag. 2.10



**FEMMINA GIREVOLE 90° JIC
SVASATA 74° INTERLOCK
INTERLOCK 90° JIC SWIVEL
FEMALE 74° CONE**

Cod. 90INTJSF..

Pag. 2.11



**MASCHIO JIC CONO 74° INTERLOCK
INTERLOCK JIC MALE 74° CONE**

Cod. INTJM..

Pag. 2.12



**MASCHIO METRICO SVASATO 24° -
SERIE PESANTE INTERLOCK
INTERLOCK METRIC MALE 24° CONE -
HEAVY TYPE**

Cod. INTMMH..

Pag. 2.13



**MASCHIO SVASATO 60° INTERLOCK
Filetto NPT
INTERLOCK MALE 60° CONE
Thread NPT**

Cod. INTNPTM..

Pag. 2.14



**FEMMINA GIREVOLE O'RING CONO 24°
SERIE PESANTE INTERLOCK**
Filetto Metrico Cilindrico
**INTERLOCK O'RING METRIC SWIVEL
FEMALE 24° CONE – HEAVY TYPE**
Thread Metric Parallel

Cod. INTORMSFH..

Pag. 2.15



**FEMMINA GIREVOLE 45° O'RING CONO
24° – SERIE PESANTE INTERLOCK**
Filetto Metrico Cilindrico
**INTERLOCK 45° O'RING METRIC SWIVEL
FEMALE 24° CONE – HEAVY TYPE**
Thread Metric Parallel

Cod. 45INTORMSFH..

Pag. 2.16



**FEMMINA GIREVOLE 90° O'RING CONO
24° – SERIE PESANTE INTERLOCK**
Filetto Metrico Cilindrico
**INTERLOCK 90° O'RING METRIC SWIVEL
FEMALE 24° CONE – HEAVY TYPE**
Thread Metric Parallel

Cod. 90INTORMSFH..

Pag. 2.17



**FEMMINA GIREVOLE O'RING CONO 24°
SERIE LEGGERA INTERLOCK**
Filetto Metrico Cilindrico
**INTERLOCK O'RING METRIC SWIVEL
FEMALE 24° CONE – LIGHT TYPE**
Thread Metric Parallel

Cod. INTORMSFL..

Pag. 2.18



**FEMMINA GIREVOLE 45° O'RING CONO
24° – SERIE LEGGERA INTERLOCK**
Filetto Metrico Cilindrico
**INTERLOCK 45° O'RING METRIC SWIVEL
FEMALE 24° CONE – LIGHT TYPE**
Thread Metric Parallel

Cod. 45INTORMSFL..

Pag. 2.19



**FEMMINA GIREVOLE 90° O'RING CONO
24° – SERIE LEGGERA INTERLOCK**
Filetto Metrico Cilindrico
**INTERLOCK 90° O'RING METRIC SWIVEL
FEMALE 24° CONE – LIGHT TYPE**
Thread Metric Parallel

Cod. 90INTORMSFL..

Pag. 2.20



**FLANGIA SAE SERIE 3000 PSI
INTERLOCK**
**INTERLOCK SAE STRAIGHT
FLANGE 3000 PSI SERIES**

Cod. INTSSF3000..

Pag. 2.21



**FLANGIA 45° SAE SERIE 3000 PSI
INTERLOCK**
**INTERLOCK 45° SAE
FLANGE 3000 PSI SERIES**

Cod. 45INTSF3000..

Pag. 2.22



**FLANGIA 90° SAE SERIE 3000 PSI
INTERLOCK**
**INTERLOCK 90° SAE
FLANGE 3000 PSI SERIES**

Cod. 90INTSF3000..

Pag. 2.23



**FLANGIA SAE SERIE 6000 PSI
INTERLOCK**
**INTERLOCK SAE STRAIGHT
FLANGE 6000 PSI SERIES**

Cod. INTSSF6000..

Pag. 2.24



**FLANGIA 45° SAE SERIE 6000 PSI
INTERLOCK**
**INTERLOCK 45° SAE
FLANGE 6000 PSI SERIES**

Cod. 45INTSF6000..

Pag. 2.25



**FLANGIA 90° SAE SERIE 6000 PSI
INTERLOCK**
**INTERLOCK 90° SAE
FLANGE 6000 PSI SERIES**

Cod. 90INTSF6000..

Pag. 2.26

**GHIERA PER TUBO EN 856 4SH
4 SH FERRULE FOR EN 856 4SH HOSE TYPE**

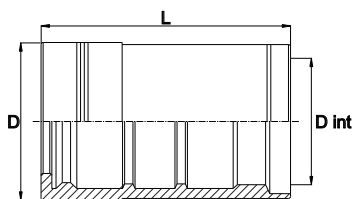

Codice Part Number	Ø Int. Tubo Inch. Hose I.D.	L	D	D int
FR4SH12**	3/4"	60,0	38,0	30,0
FR4SH16**	1"	74,0	46,0	37,2
FR4SH20	1" 1/4	88,0	55,0	44,2
FR4SH24	1" 1/2	88,0	62,0	51,3
FR4SH32	2"	99,0	79,5	66,0

** Anche per tubo SAE 100 R13 (EN 856 R13)

** Also for SAE 100 R13 (EN 856 R13) Hose type

**GHIERA PER TUBO SAE 100 R13 (EN 856 R13)
R13 FERRULE FOR SAE 100 R13 (EN 856 R13)**

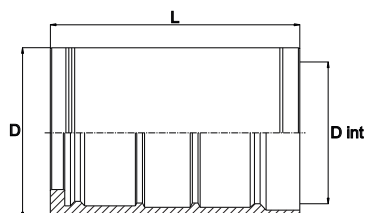

Codice Part Number	Ø Int. Tubo Inch. Hose I.D.	L	D	D int
FR1320	1"1/4	88,0	60,0	49,5
FR1324	1"1/2	88,0	67,0	56,0
FR1332	2"	99,0	84,5	71,0

MASCHIO SVASATO 60° INTERLOCK

Filetto Gas Cilindrico

INTERLOCK 60° CONE

Thread BSP Paralell

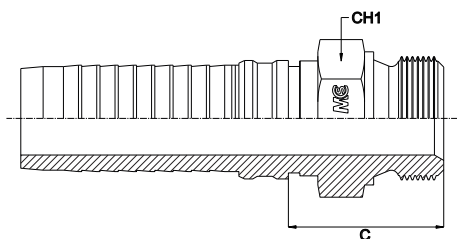

Bar W.P.	Codice Part Number	Filetto Thread	Ø Int. Tubo Inch. Hose I.D.	C Cut - Off	CH1
420	INTBSPM1212	3/4"	3/4"	34	32
414	INTBSPM1616	1"	1"	39	38
	INTBSPM2020	1"1/4	1"1/4	44	50
345	INTBSPM2424	1"1/2	1"1/2	44	55
	INTBSPM3232	2"	2"	49	70

**FEMMINA GIREVOLE GAS CONO 60° INTERLOCK
INTERLOCK BSP SWIVEL FEMALE 60° CONE**

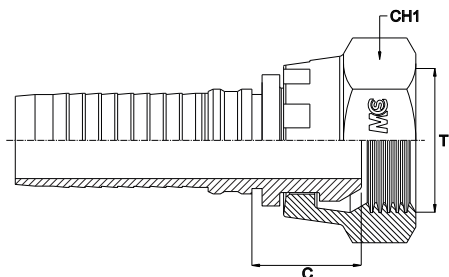

Bar W.P.	Codice Part Number	Filetto Thread	Ø Int. Tubo Inch. Hose I.D.	C Cut - Off	CH1
420	INTBSPSF1212	3/4"	3/4"	22,7	32
414	INTBSPSF1616	1"	1"	24,6	38
	INTBSPSF2020	1" 1/4	1" 1/4	25,5	50
345	INTBSPSF2424	1" 1/2	1" 1/2	29,5	55
	INTBSPSF3232	2"	2"	30,0	70

**FEMMINA GIREVOLE 45° GAS CONO 60° INTERLOCK
INTERLOCK 45° BSP SWIVEL FEMALE 60° CONE**

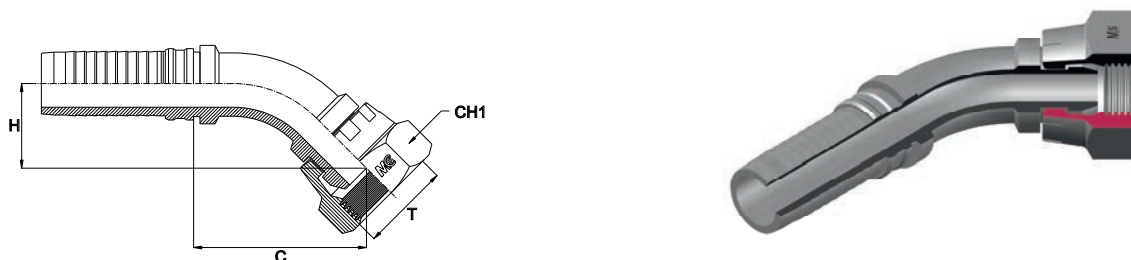

Bar W.P.	Codice Part Number	Filetto Thread	Ø Int. Tubo Inch. Hose I.D.	C Cut - Off	H Drop	CH1
420	45INTBSPSF1212	3/4"	3/4"	88,0	35,5	32
414	45INTBSPSF1616	1"	1"	110,0	40,5	38
	45INTBSPSF2020	1" 1/4	1" 1/4	136,5	45,0	50
345	45INTBSPSF2424	1" 1/2	1" 1/2	168,5	54,5	55
	45INTBSPSF3232	2"	2"	186,0	50,0	70

**FEMMINA GIREVOLE 90° GAS CONO 60° INTERLOCK
INTERLOCK 90° BSP SWIVEL FEMALE 60° CONE**

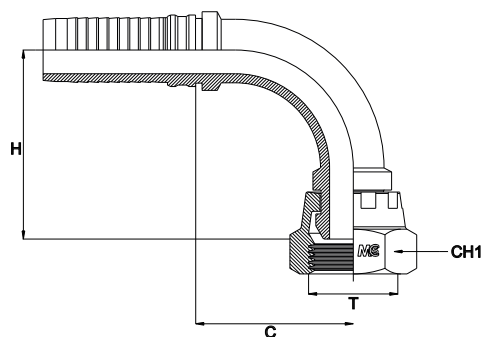

Bar W.P.	Codice Part Number	Filetto Thread	Ø Int. Tubo Inch. Hose I.D.	C Cut - Off	H Drop	CH1
420	90INTBSPSF1212	3/4"	3/4"	48,0	59,5	32
414	90INTBSPSF1616	1"	1"	65,5	77,5	38
	90INTBSPSF2020	1"1/4	1"1/4	83,0	88,0	50
345	90INTBSPSF2424	1"1/2	1"1/2	112,0	104,0	55
	90INTBSPSF3232	2"	2"	125,0	121,0	70

**FEMMINA GIREVOLE JIC SVASATA 74° INTERLOCK
INTERLOCK JIC SWIVEL FEMALE 74° CONE**

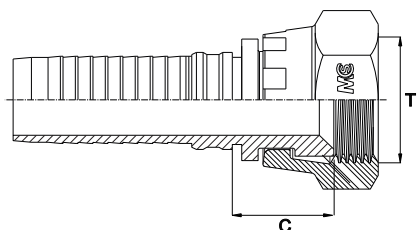

Bar W.P.	Codice Part Number	Filetto Thread	Ø Int. Tubo Inch. Hose I.D.	C Cut - Off	CH1
420	INTJSF1712	1"1/16	3/4"	22,7	32
	INTJSF2112	1"5/16	3/4"	22,7	38
414	INTJSF2116	1"5/16	1"	23,0	38
	INTJSF2620	1"5/8	1"1/4	25,5	50
345	INTJSF3024	1"7/8	1"1/2	25,5	55
	INTJSF4032	2"1/2	2"	30,0	70

**FEMMINA GIREVOLE 45° JIC SVASATA 74° INTERLOCK
INTERLOCK 45° JIC SWIVEL FEMALE 74° CONE**

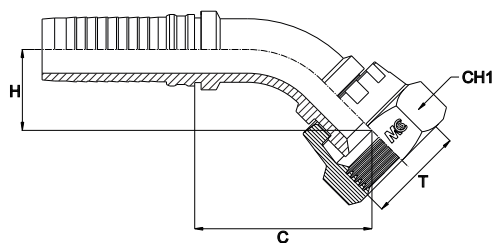

Bar W.P.	Codice Part Number	Filetto Thread	Ø Int. Tubo Inch. Hose I.D.	C Cut - Off	H Drop	CH1
420	45INTJSF1712	1" 1/16	3/4"	88,0	35,8	32
	45INTJSF2112	1" 5/16	3/4"	83,5	26,0	38
414	45INTJSF2116	1" 5/16	1"	114,5	43,0	38
	45INTJSF2620	1" 5/8	1" 1/4	134,5	45,5	50
345	45INTJSF3024	1" 7/8	1" 1/2	180,0	60,5	55

**FEMMINA GIREVOLE 90° JIC SVASATA 74° INTERLOCK
INTERLOCK 90° JIC SWIVEL FEMALE 74° CONE**

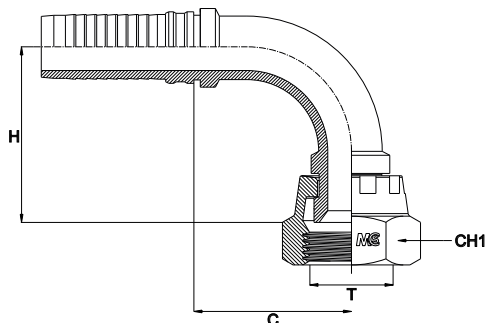

Bar W.P.	Codice Part Number	Filetto Thread	Ø Int. Tubo Inch. Hose I.D.	C Cut - Off	H Drop	CH1
420	90INTJSF1712	1"1/16	3/4"	53,0	61,0	32
	90INTJSF2112	1"5/16	3/4"	51,0	63,5	38
414	90INTJSF2116	1"5/16	1"	69,0	75,0	38
	90INTJSF2620	1"5/8	1"1/4	86,5	85,5	50
345	90INTJSF3024	1"7/8	1"1/2	117,0	109,0	55

**MASCHIO JIC CONO 74° INTERLOCK
INTERLOCK JIC MALE 74° CONE**

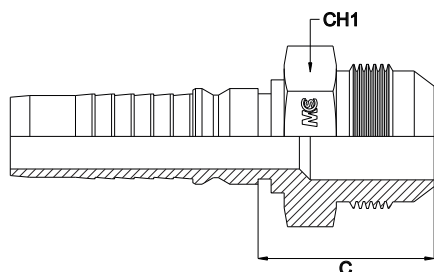

Bar W.P.	Codice Part Number	Filetto Thread	Ø Int. Tubo Inch. Hose I.D.	C Cut - Off	CH1
420	INTJM1712	1"1/16	3/4"	37,0	27
	INTJM2112	1"5/16	3/4"	40,5	36
414	INTJM2116	1"5/16	1"	41,5	36
	INTJM2620	1"5/8	1"1/4	44,0	46
345	INTJM3024	1"7/8	1"1/2	49,0	50
	INTJM4032	2"1/2	2"	-	65

MASCHIO METRICO SVASATO 24° - SERIE PESANTE INTERLOCK
INTERLOCK METRIC MALE 24° CONE - HEAVY TYPE

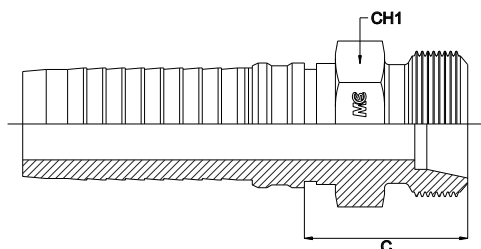

Bar W.P.	Codice Part Number	Filetto Thread	Ø Int. Tubo Inch. Hose I.D.	DIN 24°	C Cut-Off	CH1
420	INTMMH2012	30x2	3/4"	20S	32,5	30
	INTMMH2512	36x2	3/4"	25S	36,0	36
414	INTMMH2516	36x2	1"	25S	36,0	36
280	INTMMH3016	42x2	1"	30S	38,0	46
250	INTMMH3820	52x2	1" 1/4	38S	44,0	55

MASCHIO SVASATO 60° INTERLOCK

Filetto NPT

INTERLOCK MALE 60° CONE

Thread NPT

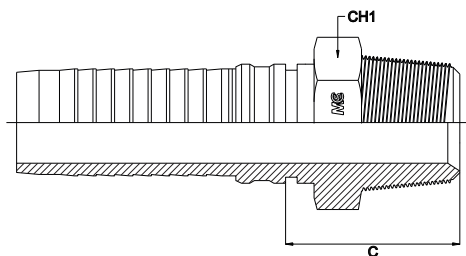

Bar W.P.	Codice Part Number	Filetto Thread	Ø Int. Tubo Inch. Hose I.D.	C Cut - Off	CH1
420	INTNPTM1212	3/4"	3/4"	34,5	27
	INTNPTM1616	1"	1"	42,5	36
	INTNPTM2020	1" 1/4	1" 1/4	45,5	46
	INTNPTM2424	1" 1/2	1" 1/2	47,0	50
345	INTNPTM3232	2"	2"	50,5	65

FEMMINA GIREVOLE O'RING CONO 24° - SERIE PESANTE INTERLOCK

Filetto Metrico Cilindrico

INTERLOCK O'RING METRIC SWIVEL FEMALE 24° CONE - HEAVY TYPE

Thread Metric Parallel

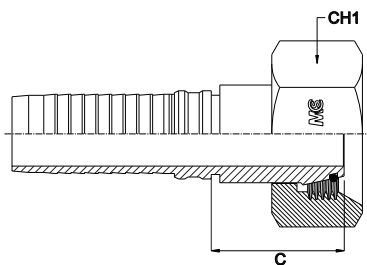

Bar W.P.	Codice Part Number	Filetto Thread	Ø Int. Tubo Inch. Hose I.D.	DIN 24°	C Cut - Off	CH1
420	INTORMSFH2012	30x2	3/4"	20S	32,0	36
	INTORMSFH2512	36x2	3/4"	25S	32,0	46
414	INTORMSFH2516	36x2	1"	25S	33,0	46
280	INTORMSFH3016	42x2	1"	30S	33,0	50
250	INTORMSFH3820	52x2	1"1/4	38S	40,0	60
	INTORMSFH3824	52x2	1"1/2	38S	40,0	60
	INTORMSFH5024	68x2	1"1/2	50S	-	80

FEMMINA GIREVOLE 45° O’RING CONO 24° - SERIE PESANTE INTERLOCK

Filetto Metrico Cilindrico

INTERLOCK 45° O’RING METRIC SWIVEL FEMALE 24° CONE - HEAVY TYPE

Thread Metric Parallel

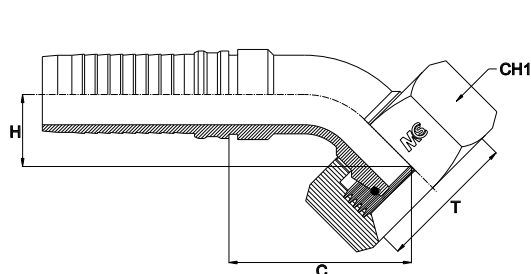

Bar W.P.	Codice Part Number	Filetto Thread	Ø Int. Tubo Inch. Hose I.D.	DIN 24°	C Cut - Off	H Drop	CH1
420	45INTORMSFH2012	30x2	3/4"	20S	85,0	29,5	36
	45INTORMSFH2512	36x2	3/4"	25S	87,0	35,0	46
414	45INTORMSFH2516	36x2	1"	25S	104,5	32,5	46
280	45INTORMSFH3016	42x2	1"	30S	108,0	35,0	50
250	45INTORMSFH3820	52x2	1" 1/4	38S	135,0	62,0	60
	45INTORMSFH3824	52x2	1" 1/2	38S	-	-	60

FEMMINA GIREVOLE 90° O’RING CONO 24° - SERIE PESANTE INTERLOCK

Filetto Metrico Cilindrico

INTERLOCK 90° O’RING METRIC SWIVEL FEMALE 24° CONE - HEAVY TYPE

Thread Metric Parallel

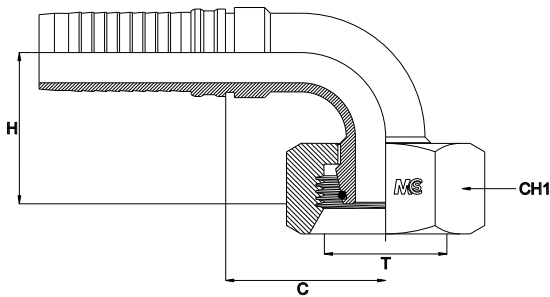

Bar W.P.	Codice Part Number	Filetto Thread	Ø Int. Tubo Inch. Hose I.D.	DIN 24°	C Cut - Off	H Drop	CH1
420	90INTORMSFH2012	30x2	3/4"	20S	50,0	64,0	36
	90INTORMSFH2512	36x2	3/4"	25S	50,5	60,5	46
414	90INTORMSFH2516	36x2	1"	25S	64,0	80,5	46
280	90INTORMSFH3016	42x2	1"	30S	64,0	77,5	50
250	90INTORMSFH3820	52x2	1" 1/4	38S	79,0	93,5	60
	90INTORMSFH3824	52x2	1" 1/2	38S	-	-	60

FEMMINA GIREVOLE O’RING CONO 24° - SERIE LEGGERA INTERLOCK

Filetto Metrico Cilindrico

INTERLOCK O’RING METRIC SWIVEL FEMALE 24° CONE - LIGHT TYPE

Thread Metric Parallel

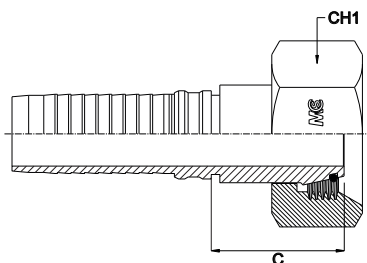

Bar W.P.	Codice Part Number	Filetto Thread	Ø Int. Tubo Inch. Hose I.D.	DIN 24°	C Cut - Off	CH1
280	INTORMSFL2212	30x2	3/4"	22L	32,5	36
185	INTORMSFL2816	36x2	1"	28L	33,0	41
165	INTORMSFL3520	45x2	1" 1/4	35L	33,0	50
130	INTORMSFL4224	52x2	1" 1/2	42L	33,0	60

FEMMINA GIREVOLE 45° O’RING CONO 24° - SERIE LEGGERA INTERLOCK

Filetto Metrico Cilindrico

INTERLOCK 45° O’RING METRIC SWIVEL FEMALE 24° CONE - LIGHT TYPE

Thread Metric Parallel

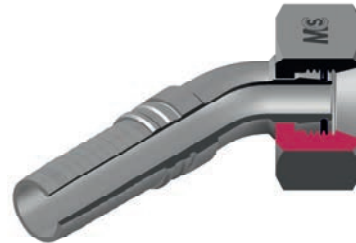
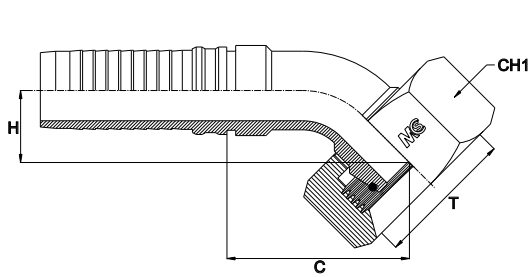

Bar W.P.	Codice Part Number	Filetto Thread	Ø Int. Tubo Inch. Hose I.D.	DIN 24°	C Cut - Off	H Drop	CH1
280	45INTORMSFL2212	30x2	3/4"	22L	-	-	36
185	45INTORMSFL2816	36x2	1"	28L	-	-	41
165	45INTORMSFL3520	45x2	1" 1/4	35L	-	-	50
130	45INTORMSFL4224	52x2	1" 1/2	42L	-	-	60

FEMMINA GIREVOLE 90° O’RING CONO 24° - SERIE LEGGERA INTERLOCK

Filetto Metrico Cilindrico

INTERLOCK 90° O’RING METRIC SWIVEL FEMALE 24° CONE - LIGHT TYPE

Thread Metric Parallel

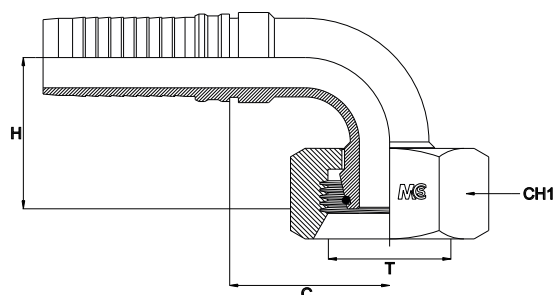

Bar W.P.	Codice Part Number	Filetto Thread	Ø Int. Tubo Inch. Hose I.D.	DIN 24°	C Cut - Off	H Drop	CH1
280	90INTORMSFL2212	30x2	3/4"	22L	53,0	60,5	36
185	90INTORMSFL2816	36x2	1"	28L	61,0	84,5	41
165	90INTORMSFL3520	45x2	1" 1/4	35L	82,5	93,5	50
130	90INTORMSFL4224	52x2	1" 1/2	42L	104,0	111,0	60

**FLANGIA SAE SERIE 3000 PSI INTERLOCK
INTERLOCK SAE STRAIGHT FLANGE 3000 PSI SERIES**

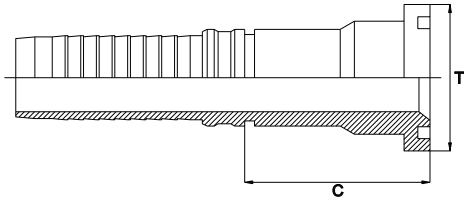

Bar W.P.	Codice Part Number	Flangia Flange	Ø Int. Tubo Inch. Hose I.D.	T	C Cut - Off
350	INTSSF30001212	3/4"	3/4"	38,1	45,0
	INTSSF30001612	1"	3/4"	44,5	-
280	INTSSF30001616	1"	1"	44,5	52,0
	INTSSF30002016	1" 1/4	1"	50,8	52,0
210	INTSSF30002020	1" 1/4	1" 1/4	50,8	53,0
	INTSSF30002420	1" 1/2	1" 1/4	60,3	60,0
185	INTSSF30002424	1" 1/2	1" 1/2	60,3	60,0
170	INTSSF30003232	2"	2"	71,4	62,0
	INTSSF30004032*	2" 1/2	2"	84,1	57,0

* Saldata

* Welded

FLANGIA 45° SAE SERIE 3000 PSI INTERLOCK
INTERLOCK 45° SAE FLANGE 3000 PSI SERIES

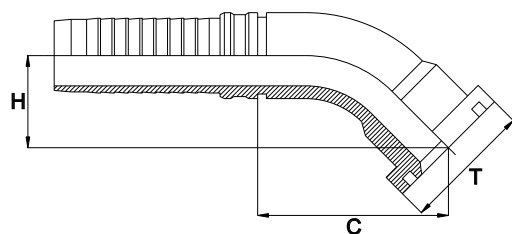

Bar W.P.	Codice Part Number	Flangia Flange	Ø Int. Tubo Inch. Hose I.D.	T	C Cut - Off	H Drop
350	45INTSF30001212	3/4"	3/4"	38,1	78,5	31,0
	45INTSF30001612	1"	3/4"	44,5	79,0	31,5
280	45INTSF30001616	1"	1"	44,5	100,0	32,0
	45INTSF30002016	1" 1/4	1"	50,8	-	-
210	45INTSF30002020	1" 1/4	1" 1/4	50,8	125,5	39,0
	45INTSF30002420	1" 1/2	1" 1/4	60,3	-	-
185	45INTSF30002424	1" 1/2	1" 1/2	60,3	168,0	46,0
	45INTSF30003224*	2"	1" 1/2	71,4	-	-
170	45INTSF30003232	2"	2"	71,4	-	-

* Saldata

* Welded

**FLANGIA 90° SAE SERIE 3000 PSI INTERLOCK
INTERLOCK 90° SAE FLANGE 3000 PSI SERIES**

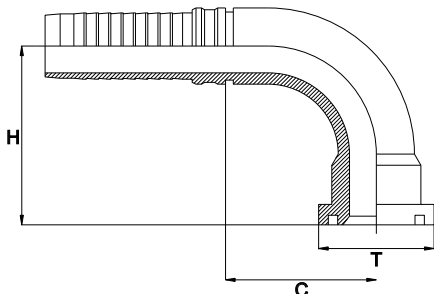

Bar W.P.	Codice Part Number	Flangia Flange	Ø Int. Tubo Inch. Hose I.D.	T	C Cut - Off	H Drop
350	90INTSF30001212	3/4"	3/4"	38,1	48,5	61,5
	90INTSF30001612	1"	3/4"	44,5	47,5	65,0
280	90INTSF30001616	1"	1"	44,5	63,0	77,0
	90INTSF30002016	1" 1/4	1"	50,8	60,0	79,0
210	90INTSF30002020	1" 1/4	1" 1/4	50,8	78,5	99,0
	90INTSF30002420	1" 1/2	1" 1/4	60,3	74,0	105,5
185	90INTSF30002424	1" 1/2	1" 1/2	60,3	109,5	110,5
	90INTSF30003224*	2"	1" 1/2	71,4	125,5	127,0
170	90INTSF30003232	2"	2"	71,4	-	-

* Saldata

* Welded

FLANGIA SAE SERIE 6000 PSI INTERLOCK
INTERLOCK SAE STRAIGHT FLANGE 6000 PSI SERIES

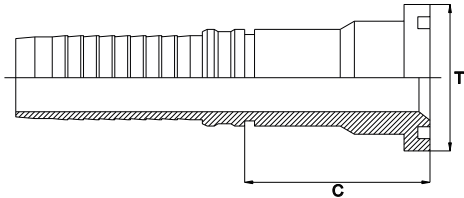

Bar W.P.	Codice Part Number	Flangia Flange	Ø Int. Tubo Inch. Hose I.D.	T	C Cut - Off
420	INTSSF60001212	3/4"	3/4"	41,3	51,0
	INTSSF60001612	1"	3/4"	47,6	56,0
415	INTSSF60001616	1"	1"	47,6	57,0
	INTSSF60002016	1" 1/4	1"	54,0	57,0
	INTSSF60002020	1" 1/4	1" 1/4	54,0	65,0
345	INTSSF60002420	1" 1/2	1" 1/4	63,5	69,0
	INTSSF60002424	1" 1/2	1" 1/2	63,5	75,0
	INTSSF60003232	2"	2"	79,4	63,0
	INTSSF60004032*	2" 1/2	2"	79,4	57,0

* Saldata

* Welded

FLANGIA 45° SAE SERIE 6000 PSI INTERLOCK
INTERLOCK 45° SAE FLANGE 6000 PSI SERIES

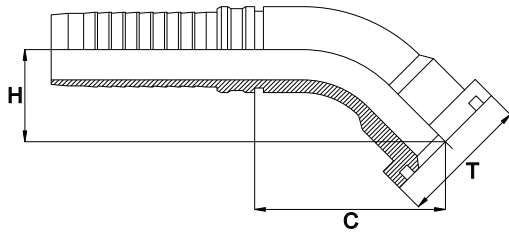

Bar W.P.	Codice Part Number	Flangia Flange	Ø Int. Tubo Inch. Hose I.D.	T	C Cut - Off	H Drop
420	45INTSF60001212	3/4"	3/4"	41,3	-	-
	45INTSF60001612	1"	3/4"	47,6	-	-
415	45INTSF60001616	1"	1"	47,6	94,2	31,8
	45INTSF60002016	1" 1/4	1"	54,0	-	-
	45INTSF60002020	1" 1/4	1" 1/4	54,0	-	-
	45INTSF60002420	1" 1/2	1" 1/4	63,5	-	-
345	45INTSF60002424	1" 1/2	1" 1/2	63,5	-	-
	45INTSF60003224*	2"	1" 1/2	79,4	-	-
	45INTSF60003232	2"	2"	79,4	-	-

* Saldata

* Welded

FLANGIA 90° SAE SERIE 6000 PSI INTERLOCK
INTERLOCK 90° SAE FLANGE 6000 PSI SERIES

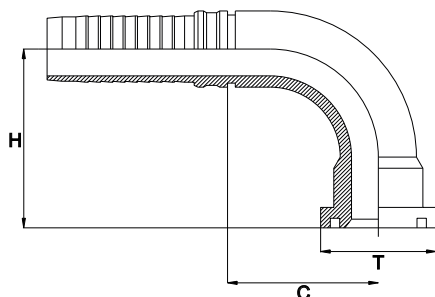

Bar W.P.	Codice Part Number	Flangia Flange	Ø Int. Tubo Inch. Hose I.D.	T	C Cut - Off	H Drop
420	90INTSF60001212	3/4"	3/4"	41,3	46,5	63,0
	90INTSF60001612	1"	3/4"	47,6	52,0	61,5
415	90INTSF60001616	1"	1"	47,6	58,0	76,0
	90INTSF60002016	1" 1/4	1"	54,0	57,0	83,0
	90INTSF60002020	1" 1/4	1" 1/4	54,0	84,5	95,5
	90INTSF60002420	1" 1/2	1" 1/4	63,5	-	-
345	90INTSF60002424	1" 1/2	1" 1/2	63,5	108,0	118,0
	90INTSF60003224*	2"	1" 1/2	79,4	-	-
	90INTSF60003232	2"	2"	79,4	125,0	130,0

* Saldata

* Welded